

Assembly Instructions / Instrucciones De Montaje

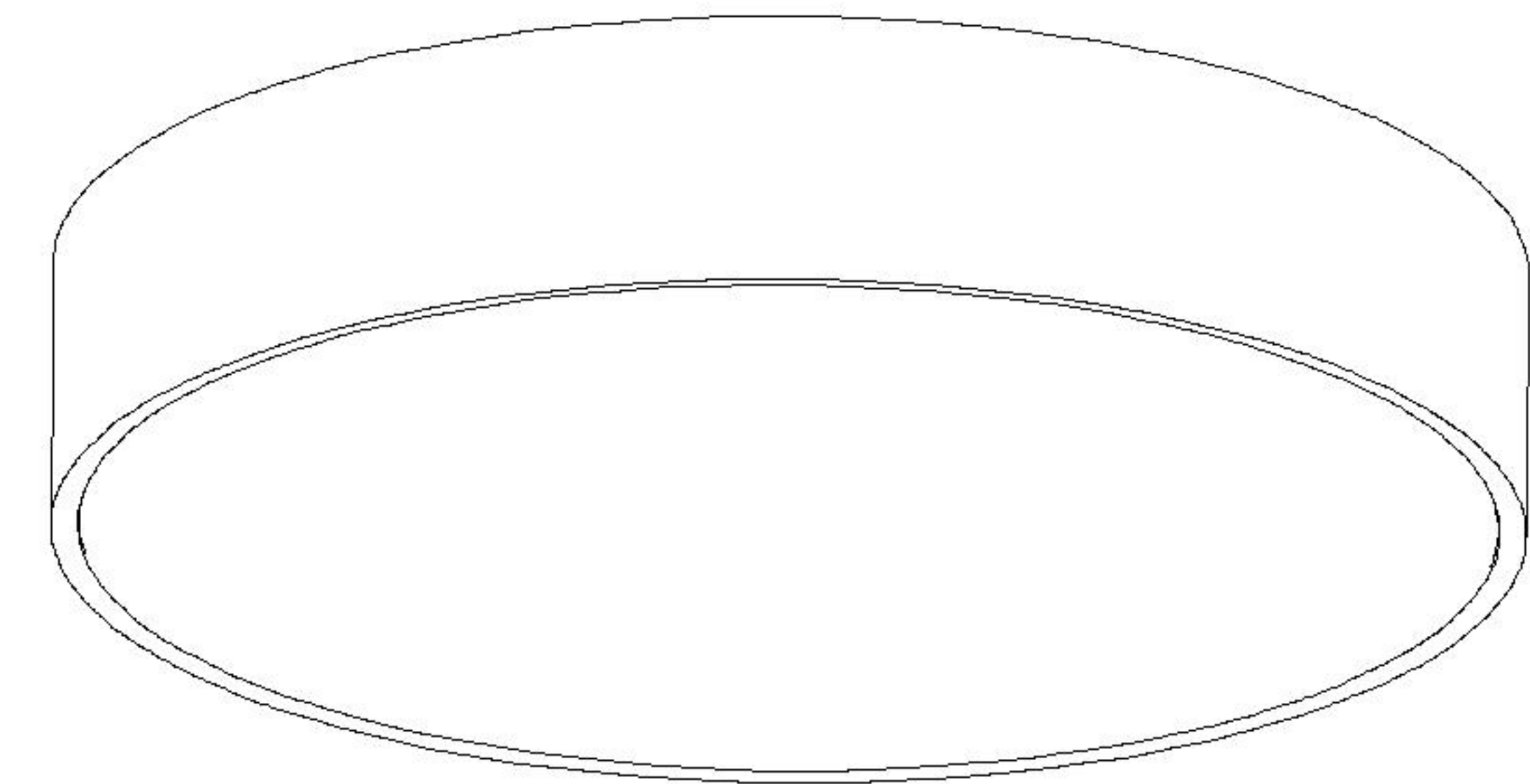
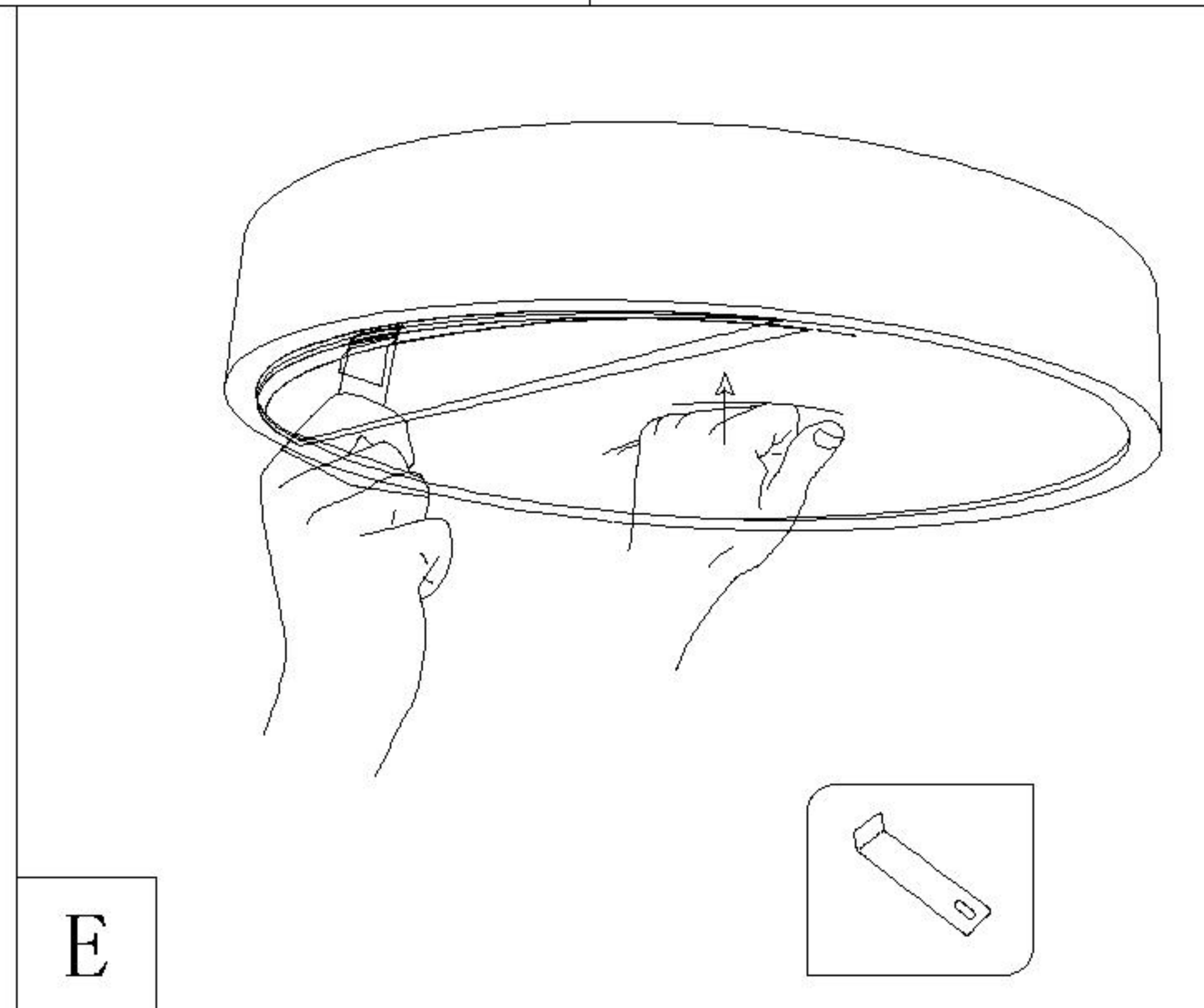
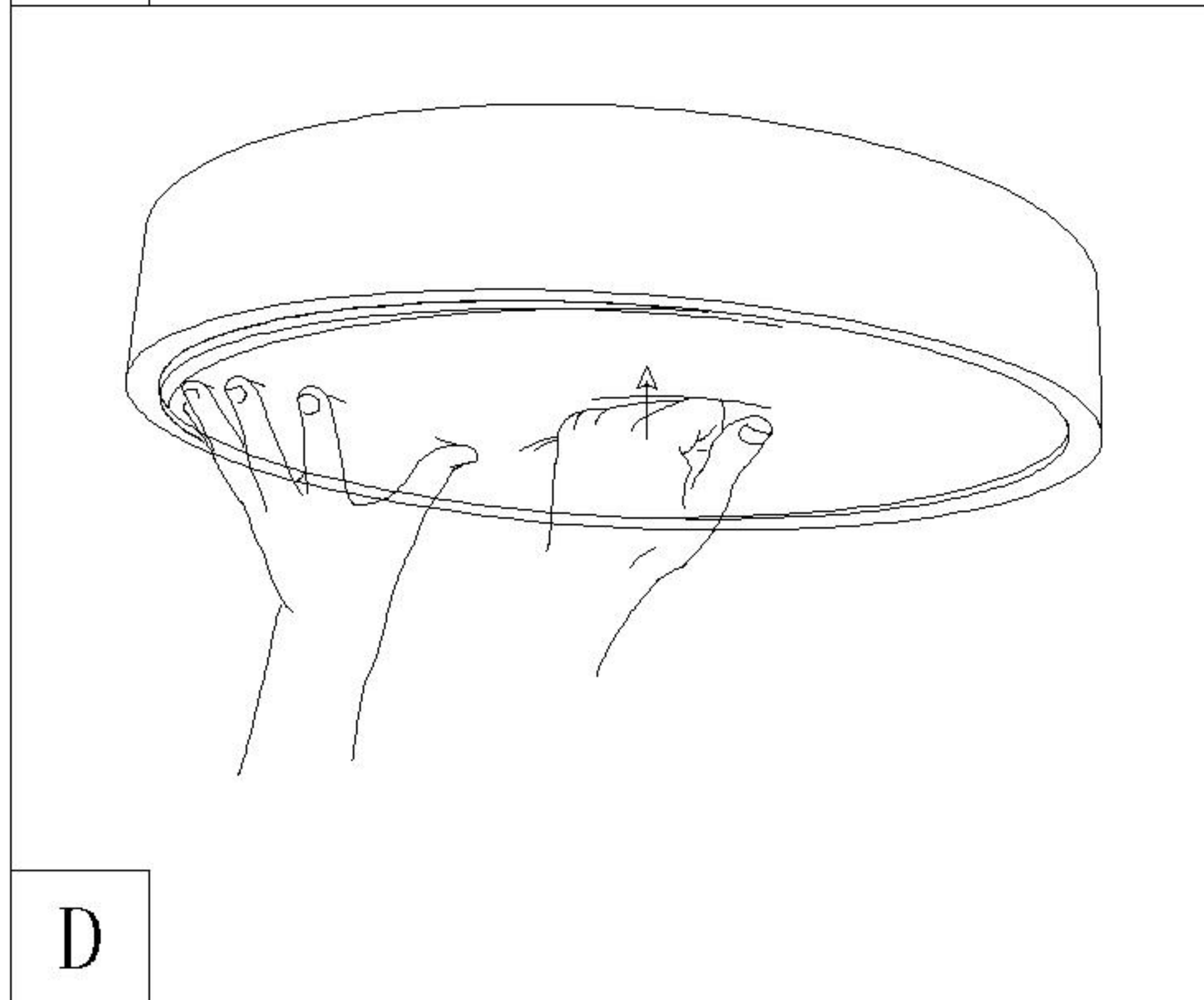
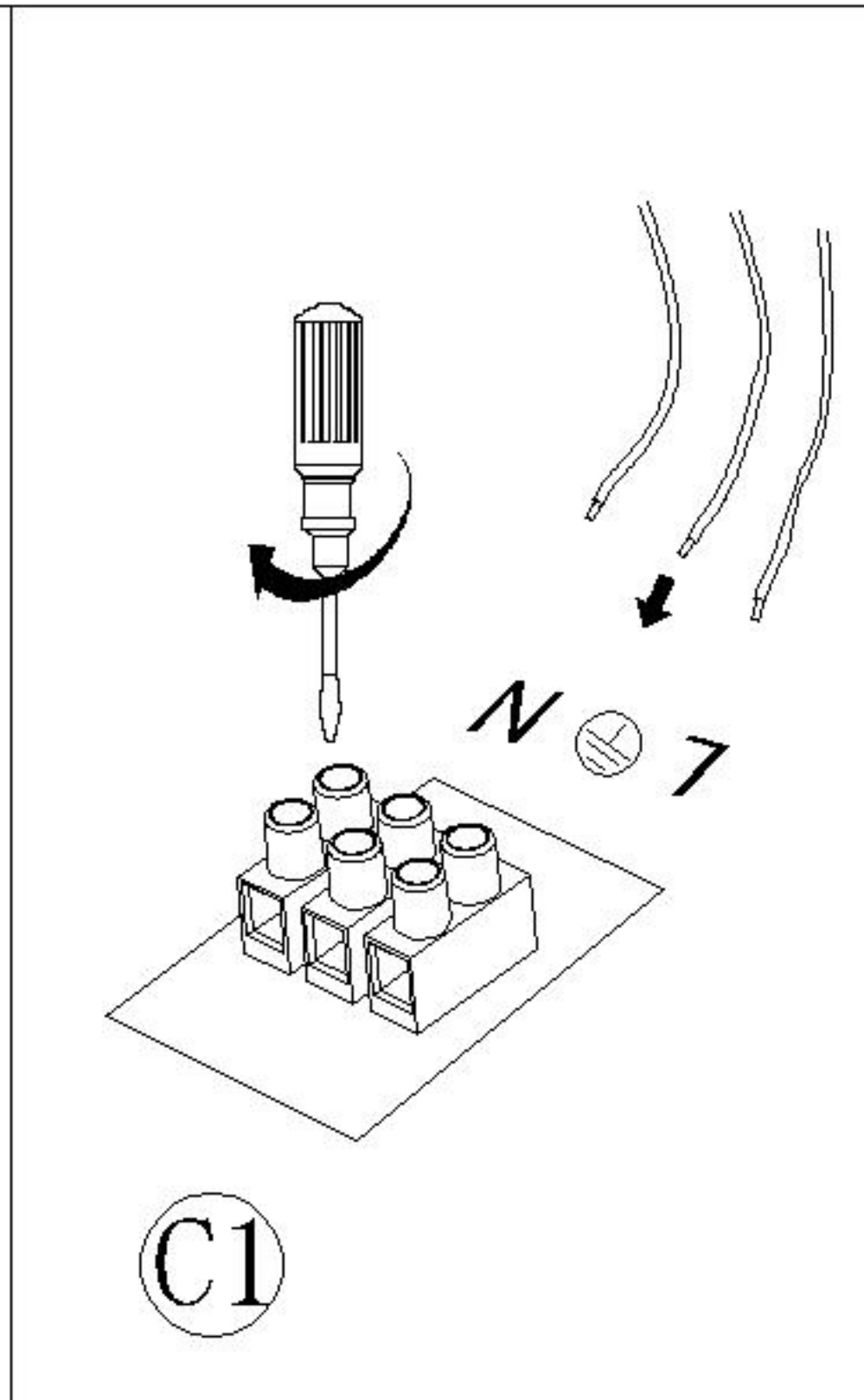
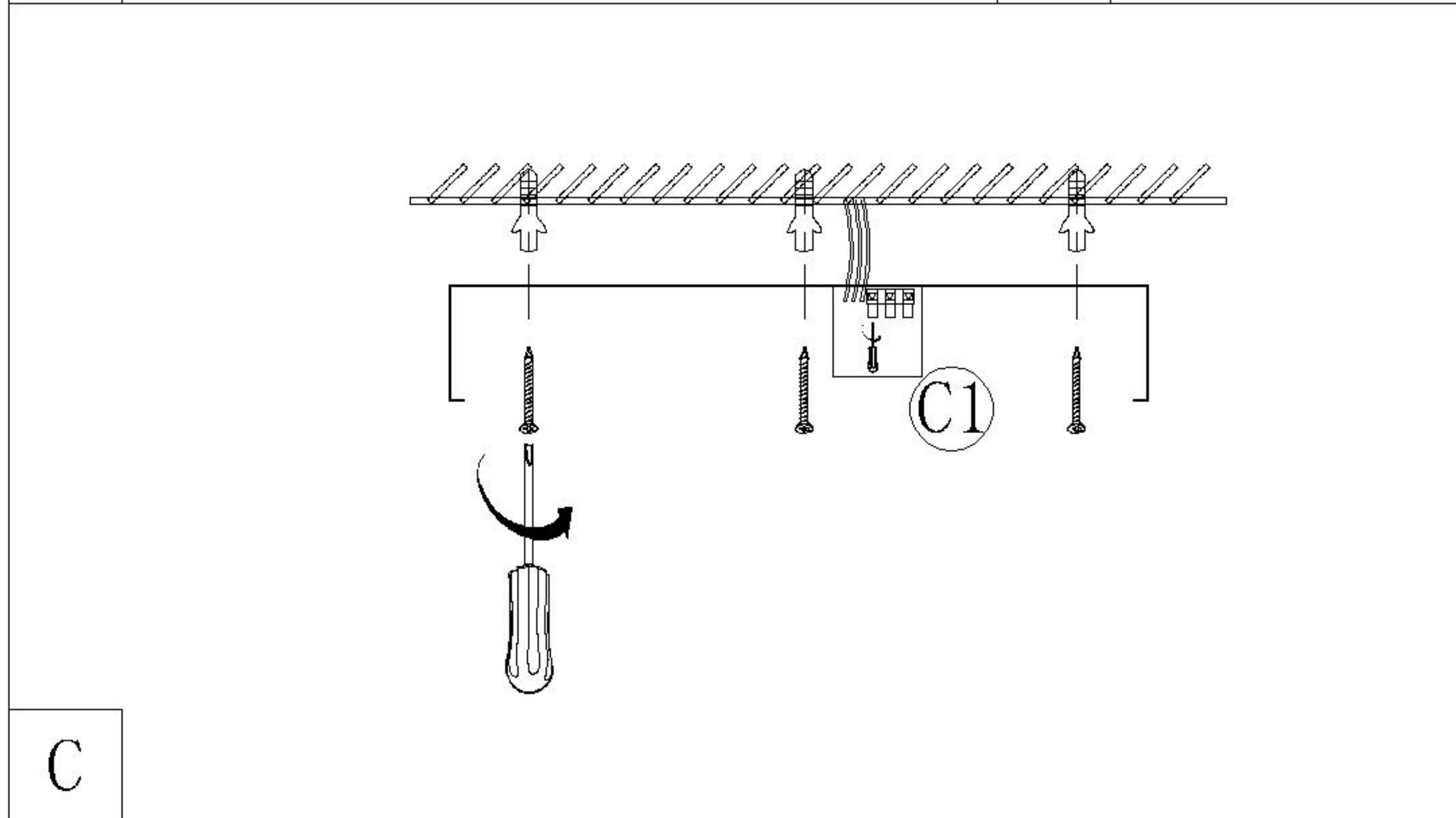
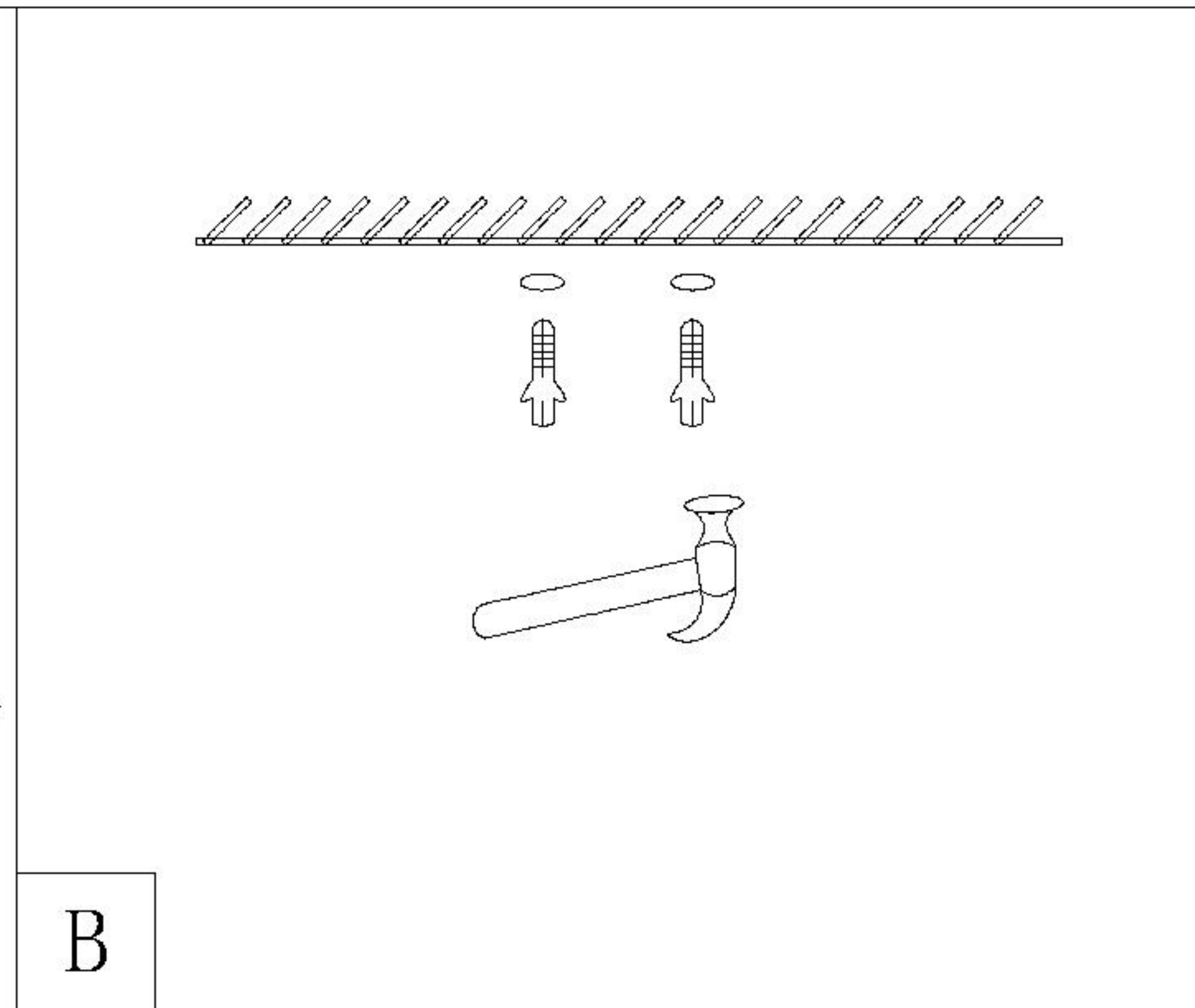
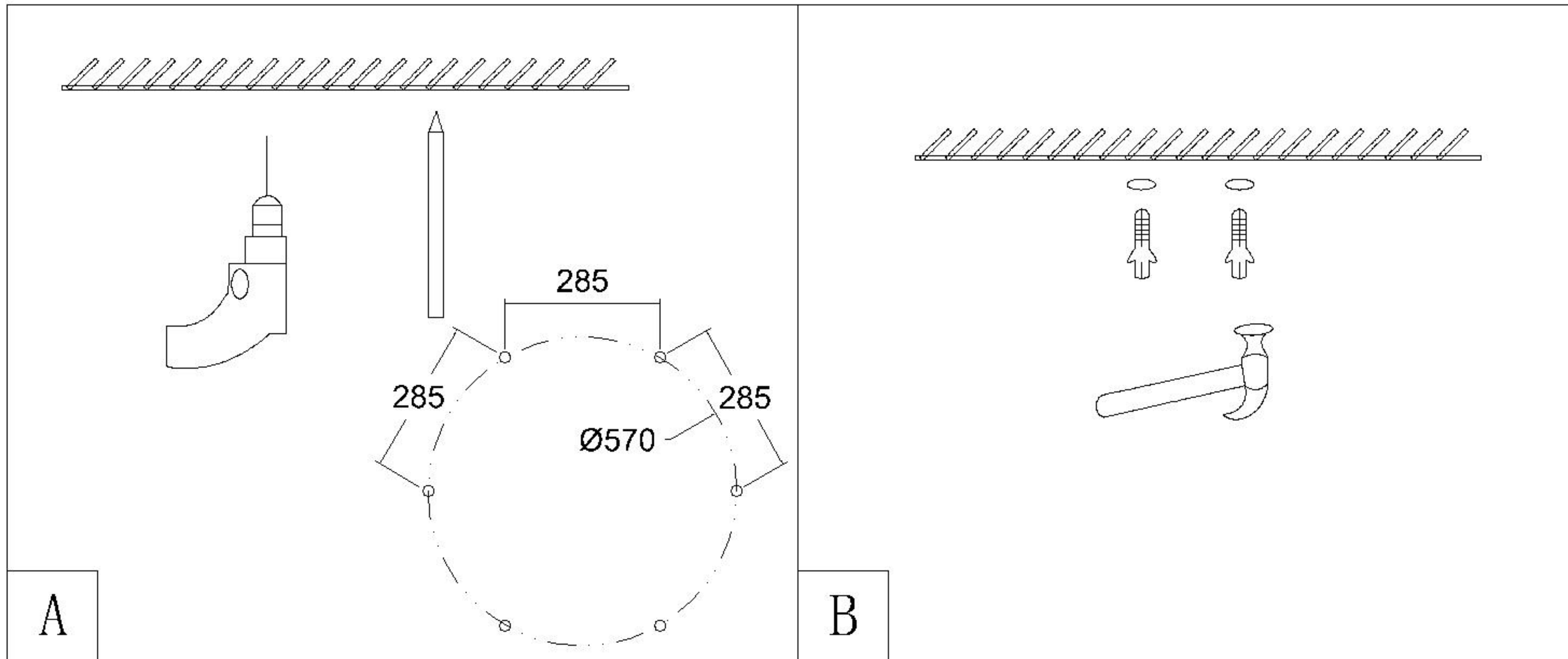

LED 90W / incl.
220-240V~ 50/60Hz

NOTE:

- 1: This lighting is only for indoor use.
- 2: Do not switch on before assembling.

NOTA:

- 1: Esta lámpara solo podrá utilizarse en interior.
- 2: No enchufe la lámpara antes de montarla.

REF.: 6151

m ntra