

INSTALLATION INSTRUCTIONS

(ILLUSTRATIONS ARE FOR GUIDANCE PURPOSES ONLY.
ACTUAL PRODUCT MAY DIFFER FROM THE IMAGES SHOWN)

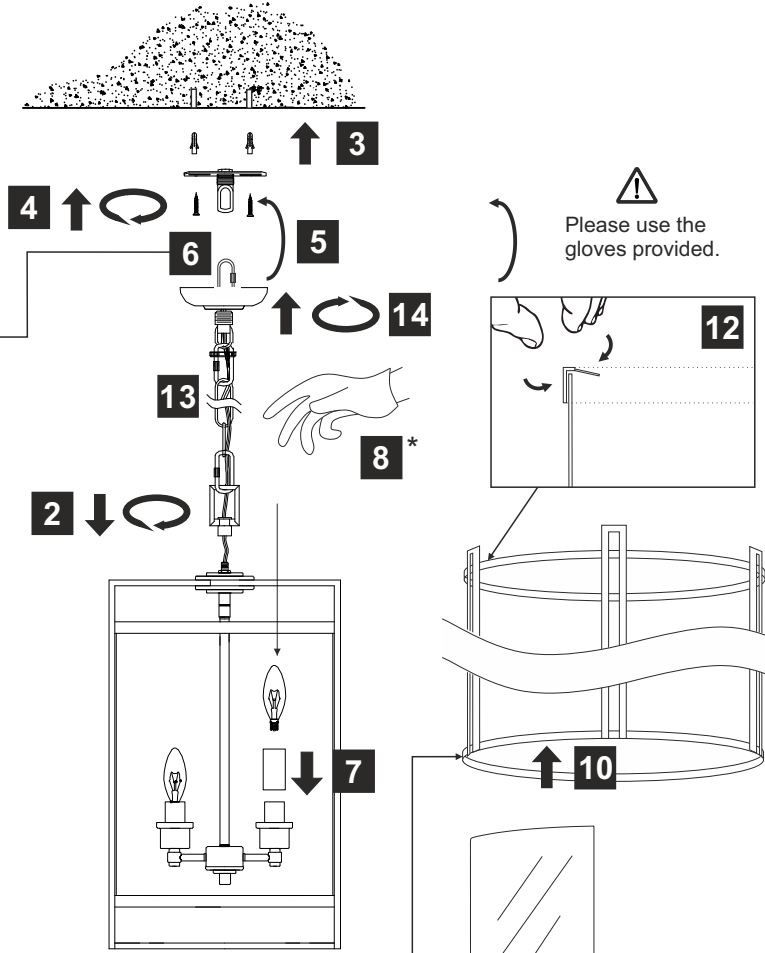

- (1) Prior to installation carefully unpack and check all the components and accessories are as per details enclosed.
- (2) These instructions should be used in conjunction with the installation guidelines included.

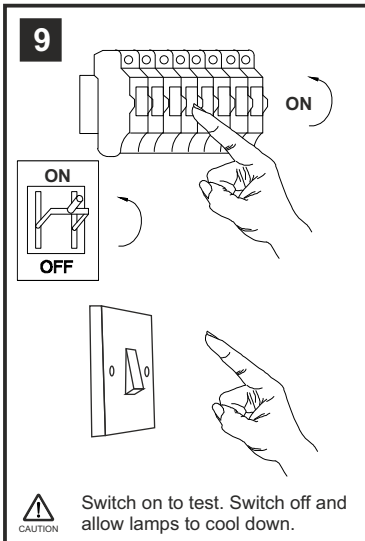
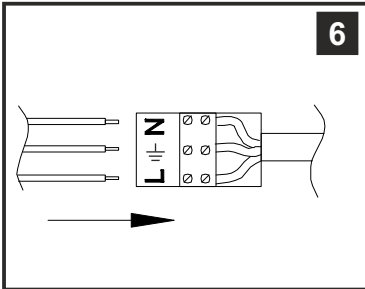
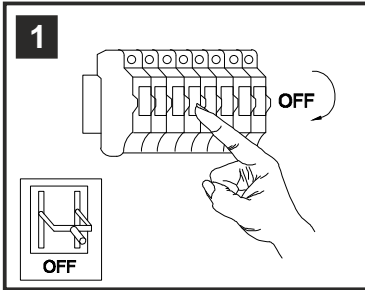

Please use the gloves provided.

* Lamps may not be included.

Please do not exceed maximum wattage.

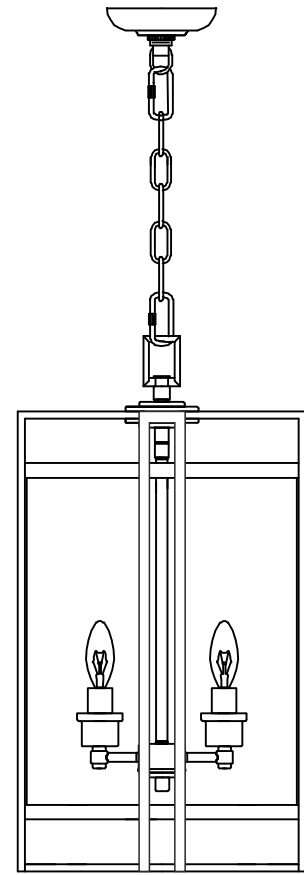

Voltage: 230V - 50/60Hz
Lampholder: E14/SES
Lamps: 4 x 60W Max

COMPATIBLE WITH SUITABLE LAMP/DIMMER

Eaton IL31083 / IL31093

LIST OF COMPONENTS

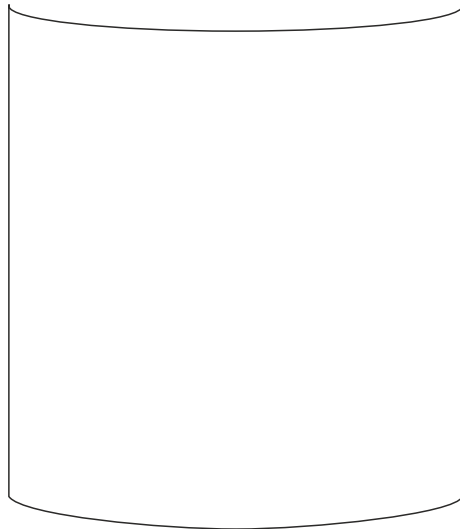

ILG31093

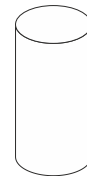

Accessories		
Glass Shade	4 Pcs	
Lampholder Sleeve 60mm x 32mm	4 Pcs	

Installation Pack		
White Gloves	2 Pcs	
Installation Instructions	2 Pages	
Installation Guidelines	2 Pages	
Fixing Screw and Plug	2 Sets	

Contents Checked By	
----------------------------	--

Eaton IL31083 / IL31093

