

## Wiring

Having correctly identified the wiring from your existing light fitting, pull the wire through the hole and connect to the connection block inside the product in the following way:

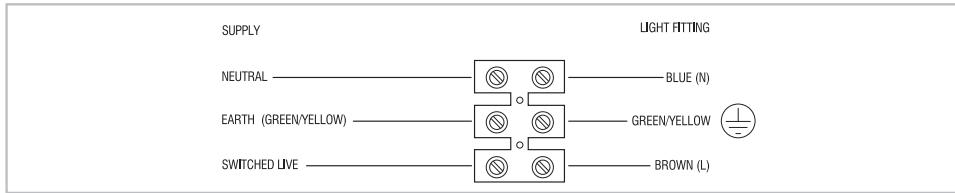

## Check that...

- You have correctly identified the wires.
- The connections are tight.
- No loose strands have been left out of the connection block.
- When completed, ensure that there are no bare or loose strands of wire exposed, and cover all exposed areas of the connection block with 2 layers of insulation tape.

## Care and Safety

- We recommend cleaning with a soft dry cloth. Do not use solvents or abrasive cleaners as these could damage the finish.
- For your safety, always switch off the power supply before cleaning.

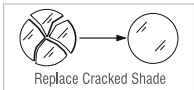

This LED's are protected by a plastic lens. The lens part must be replaced immediately should it become cracked or damaged. This fitting must not be used without the plastic lens in place.

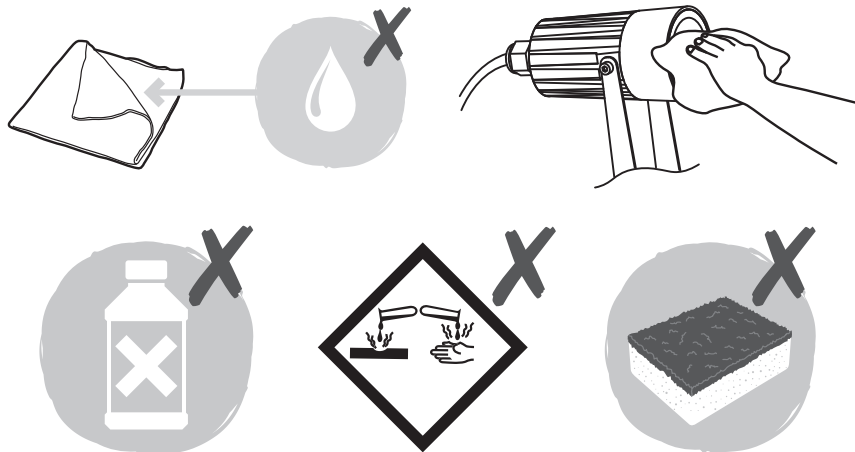

## Instruction leaflet

# Lance Spike

79192



V2 04/09/2019

CE

saxby  
lighting

Thank you for purchasing this light fitting. Please read the instructions carefully before use to ensure safe and satisfactory operation of this product. Please retain these instructions for future reference.

## Warning

Please read these instructions carefully before commencing any work.

This unit must be fitted by a competent and qualified electrician.

Install in accordance with IEE Wiring regulations and current Building Regulations.

Check the pack and make sure you have all of the parts listed.

To prevent electrocution switch off at mains supply before installing or maintaining this fitting.

Ensure other persons cannot restore the electrical supply without your knowledge.

This light fitting should be connected to a fused circuit.

If replacing an existing fitting, make a careful note of the connections.

This product is unsuitable for immersion in water.

Cables must be protected using suitable conduit or plastic trunking.

The mains supply cable must have a minimum cross sectional area of 1.0mm<sup>2</sup>.

This system contains non-replaceable parts and cannot be serviced. If damage occurs the part should be scrapped.





Take care not to drill into any pipes or mains cables beneath the surface during mounting holes preparation.

This product is not suitable for location in or near a marine environment.

The distance between the cable entry and the ground surface should be at least 10cm when installing the spike.

The product will not withstand long periods of immersion in water.

## Technical data

Supply Voltage:	240V~, 50 Hz
Bulb Type:	7W LED COB 4000K
	The light source of this luminaire is not replaceable; when the light source reaches its end of life the whole luminaire shall be replaced.
	Conformity with all relevant EC Directive requirements.
	Waste electrical products should not be disposed of with household waste. Please recycle where facilities exist. Check with your Local Authority or local store for recycling advice.
	Class I product, must be connected to earth.
	This product is not suitable for dimming.
<b>IP65</b>	Jet-proof

## Installation

Existing fittings must be completely removed before installation of a new product. Before removing the existing fitting, carefully note the position of each set of wires.

- Note that the power needs to be isolated/switched off at the fuse board.
- Plan the desired layout of this fitting carefully, ensuring the cables will reach the distance between the junction box and the light fitting.
- Decide on the position of the luminaire. Depending on the location, an approved outdoor rated plug and socket may be required. Alternatively an approved outdoor rated external terminal block may be used.
- Avoid locating any cables in positions that would cause a hazard. Position cables and connector block away from areas where they may be at risk from being cut, trapped or damaged.
- Ensure that the ground is suitable for pushing the spike into, and can support the luminaire. Do not install in very wet or boggy areas.
- Power-on. Your light is now ready for use.

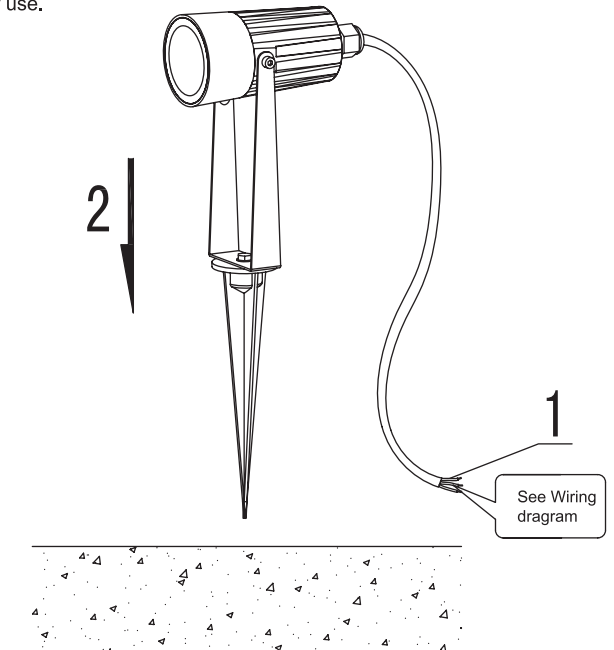

## Plug Fitting

Alternatively, the product can be connected to a 3 pin plug.

- The appliance must be connected to a 240 volts AC supply.
- The appliance can be fitted to a rewirable 3 pin plug fitted with a 3 amp fuse. Should the fuse require replacement, it must be replaced with a fuse rated at 3 amp and approved to BS1362.
- If the mains plug is unsuitable for the socket outlet or is removed for any other reason, then the cut off plug should be disposed of safely to prevent the hazard of electric shock.
- There is a danger of electric shock if the cut off plug is inserted into any 13 amp socket outlet.

