

Wiring

Terminal block not included. Installation may require advice from a qualified person. Connect to an approved outdoor rated terminal block, observing the wiring diagram here:

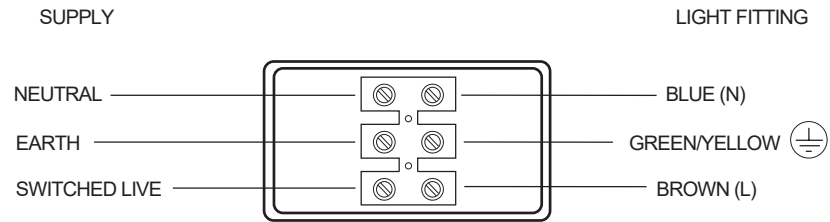

Check that...

- You have correctly identified the wires.
- The connections are tight.
- No loose strands have been left out of the terminals.

Care and Safety

- We recommend cleaning with a soft dry cloth. Do not use solvents or abrasive cleaners as these could damage the finish.
- For your safety, always switch off the supply before cleaning.

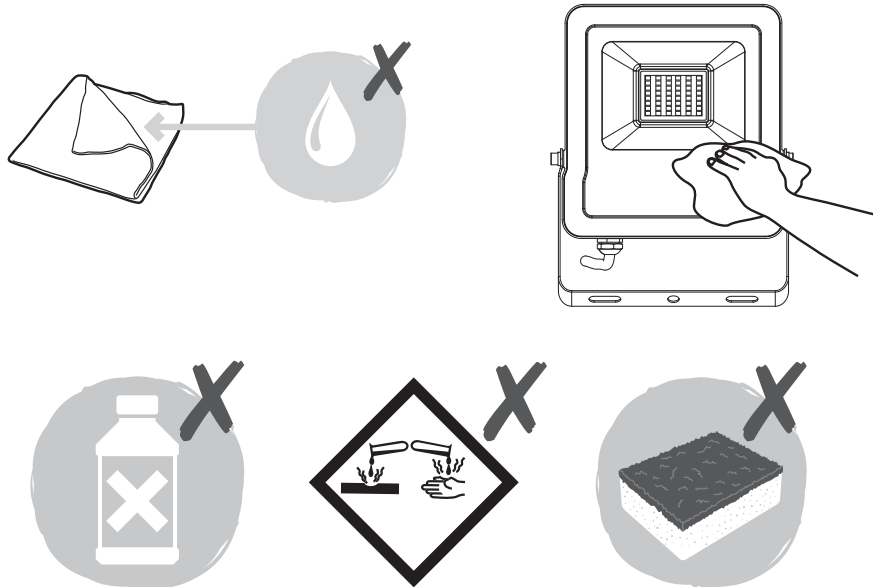

Iss .2 22/11/2018

Saxby lighting. BH23 3PE

Instruction leaflet

Surge (Floodlight)

78962, 78964, 78966, 78968, 78970



CE

saxby
lighting

Thank you for purchasing this light fitting. Please read the instructions carefully before use to ensure safe and satisfactory operation of this product. Please retain these instructions for future reference.

Warning

Please read these instructions carefully before commencing any work.

This unit must be fitted by a competent and qualified electrician.

Install in accordance with IEE Wiring regulations and current Building Regulations.

Check the pack and make sure you have all of the parts listed.

To prevent electrocution switch off at mains supply before installing or maintaining this fitting. Ensure other persons cannot restore the electrical supply without your knowledge.

If replacing an existing fitting, make a careful note of the connections.

The entire unit gets hot whilst on for a period of time.

This light fitting should be connected to a circuit with a 30mA RCD fitted.

This product is not suitable for location in or near a marine environment.





The external flexible cable or cord of this luminaire cannot be replaced; if the cord is damaged, the luminaire must be destroyed.

This product is supplied with 1 metres of H05RN-F outdoor grade rubber sheathed cable - ready for connection to an approved, outdoor rated terminal block which is not supplied and must be obtained.

This is a floodlight product, and therefore should be positioned where it will not cause a glare hazard.

Terminal block not included. Installation may require advice from a qualified person.

Technical data

Supply Voltage:	240V~, 50 Hz
Bulb Type:	78962 : 10W SMD 2835 4000K 78964 : 20W SMD 2835 4000K 78966 : 30W SMD 2835 4000K 78968 : 50W SMD 2835 4000K
	The light source of this luminaire is not replaceable; when the light source reaches its end of life the whole luminaire shall be replaced.
	Conformity with all relevant EC Directive requirements.
	Waste electrical products should not be disposed of with household waste. Please recycle where facilities exist. Check with your Local Authority or local store for recycling advice.
	Class I product, must be connected to earth.
	This product is not suitable for dimming.
IP65	Jet- proof

Installation

Existing fittings must be completely removed before installation of a new product. Before removing the existing fitting, carefully note the position of each set of wires.

- Note that the power needs to be isolated/switched off at the fuse board.
- Plan the desired layout of this fitting carefully, ensuring the cables will reach the distance between the junction box and the light fitting.
- Avoid locating any cables in positions that would cause a hazard. Position cables and outdoor rated junction boxes (not supplied) away from areas where they may be at risk from being cut, trapped or damaged.
- Cables must be protected using suitable conduit or plastic trunking.
- Lights can install on the ground, wall or brackets according to actual situation such as installation on the brackets with hexagonal head screw fixed. And dig the hole on ground or wall with suitable expansion bolt (not provide) fixing according to light's bracket if install on the ground or wall.

Installed on the ground

- Hold the product in position and mark the location of the fixing holes. The bracket can be removed from the fitting for ease of installation.
- Drill and plug the wall at the marked positions.
- Use screw fix the bracket to the accessory "78970".
- Mount the product on the bracket and adjust the desired angle
- Wire as detailed wiring.
- Refit the cover on the IP terminal block. Ensure that the seals are correctly located, and refit the screws.

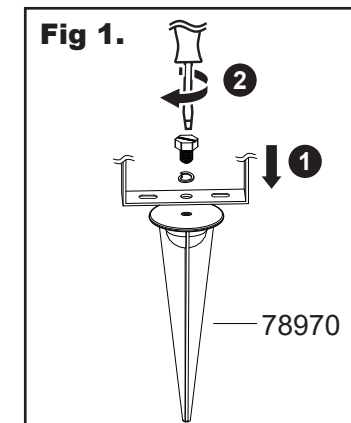

Installed on the Wall

- Hold the product in position and mark the location of the fixing holes. A minimum of two fixing points must be used. Ensure the wall is capable of holding the weight of the product. The bracket can be removed from the fitting for ease of installation
- Drill and plug the wall at the marked positions.
- Wire as detailed wiring.
- Refit the cover on the IP terminal block. Ensure that the seals are correctly located, and refit the screws.
- Fix the bracket to the wall using the screws and plugs (not provided). Take care to avoid damaging any concealed wiring and pipes. The correct fixings should be used for brick or cavity walls.
- Using the allen key (not supplied), loosen the bolts on the side, and adjust the fitting to the desired position. Ensure that the cable is not snagged. Re-tighten the bolts.

