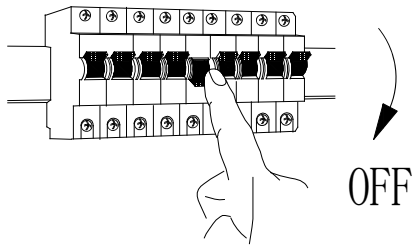
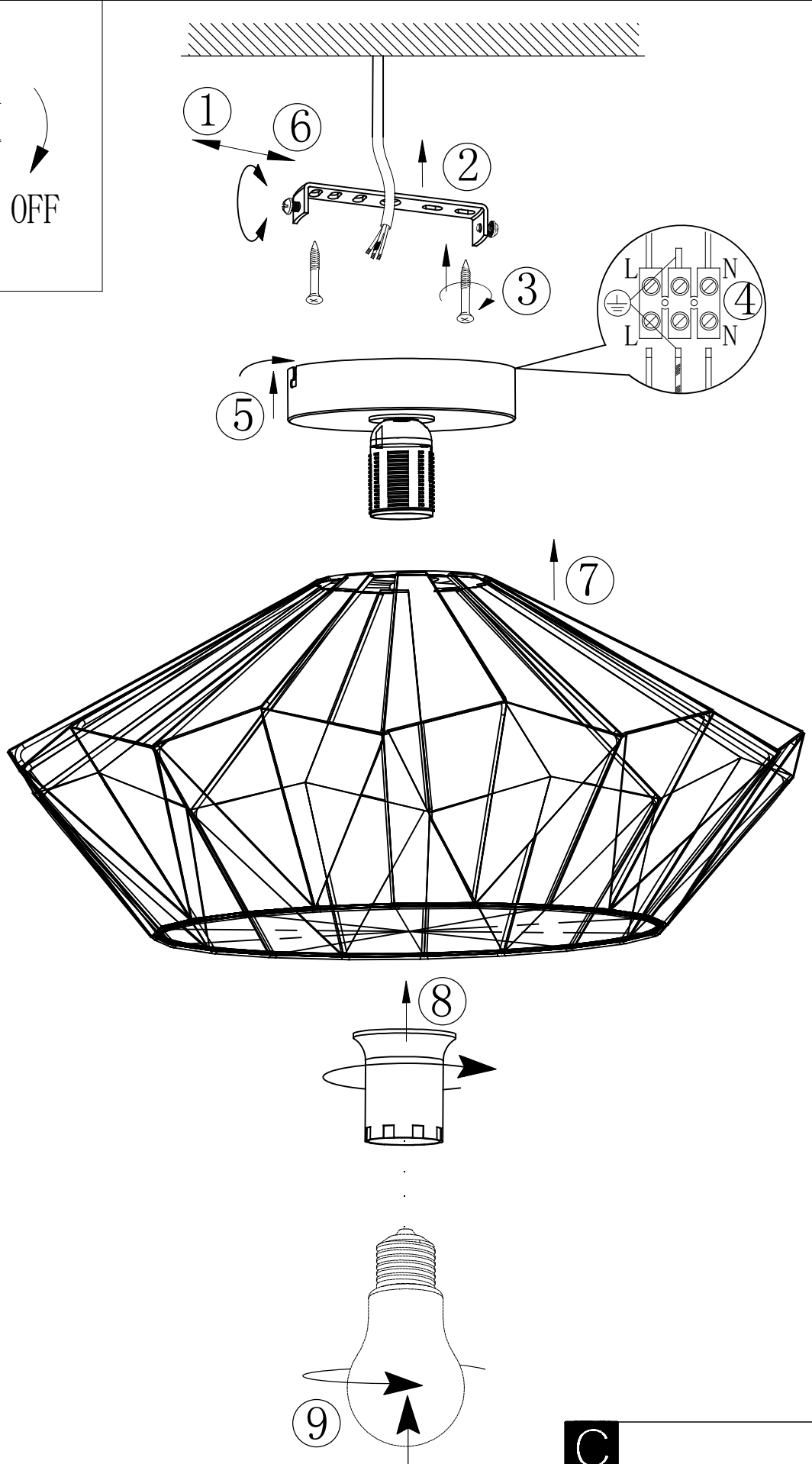
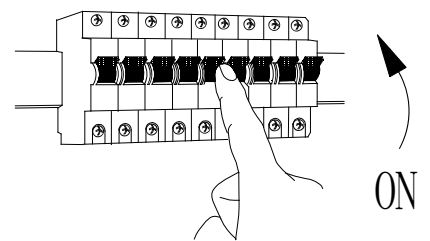

**A****B****C**

BLA43399  
 www.eglo.com