



## Levels 1 Body Ø220mm

Nahtrang Design

Pendant Levels 1 Body Ø220mm LED 19 SW 2700-3000-4000K CASAMBI Black 1255lm

### Technical features

- Luminaire total power: 19W
- Real lumens: 1255 (3000K)
- Real lm/W: 66
- Correlated Colour Temperature (CCT): SW 2700-3000-4000K
- Lens / reflector angle: HORIZONTAL 102°
- Structure material: Steel
- Structure finish: Black
- Diffuser material: Glass
- Diffuser finish: Green
- Voltage / frequency: 110-277V/50-60Hz
- Dimming protocol: CASAMBI
- Power Factor: NULL
- Useful life: 50,000h L80B20
- Warranty: 5 años
- Easily recyclable luminaire



### Luminotechnic features

- CRI: 90
- MacAdam steps: 3
- Photobiological risk: RG1

Lampholder	Quantity	Light source power (W)
LED	1	17.2W

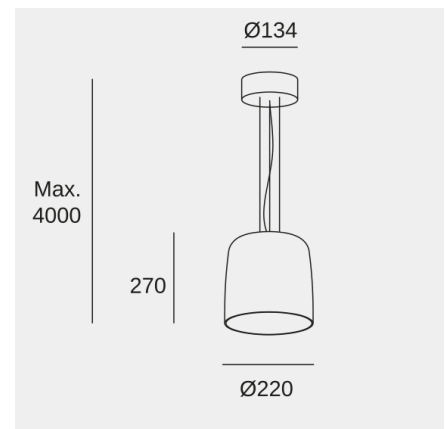

Image may not match reference. LedsC4 reserves the right to amend any of the product's components. The data related to flux, power and colour temperature may be subject to changes made by the manufacturer.



## Levels 1 Body Ø220mm

Nahtrang Design

Pendant Levels 1 Body Ø220mm LED 19 SW 2700-3000-4000K CASAMBI Black 1255lm

### Bluetooth range

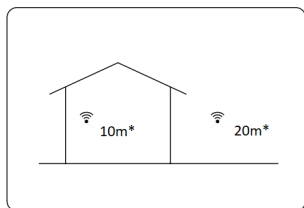

The Bluetooth range largely depends on the obstacles and architectural features of a space, such as walls and building materials

### Logistics

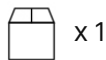

Net weight (kg): 2.43

Packaged weight (kg): 3.26

Packaging: 325mm x 330mm x 455mm

Image may not match reference. LedsC4 reserves the right to amend any of the product's components. The data related to flux, power and colour temperature may be subject to changes made by the manufacturer.