

Assembly Instructions / Instrucciones De Montaje

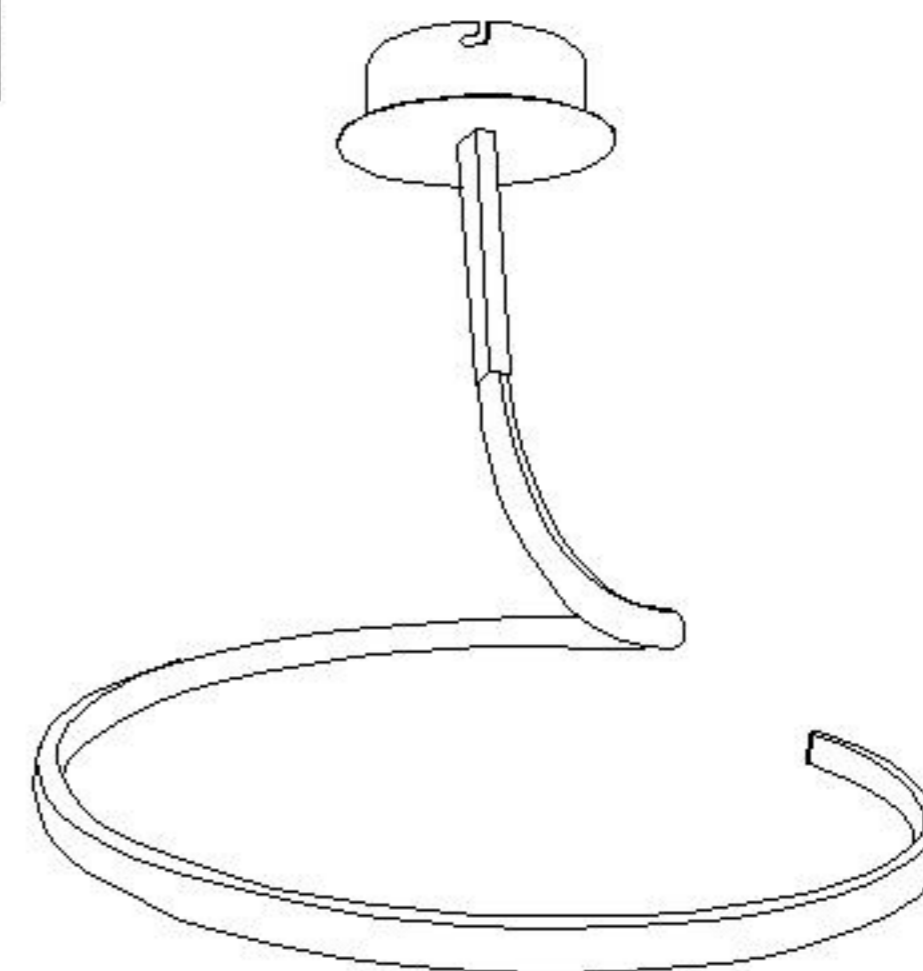
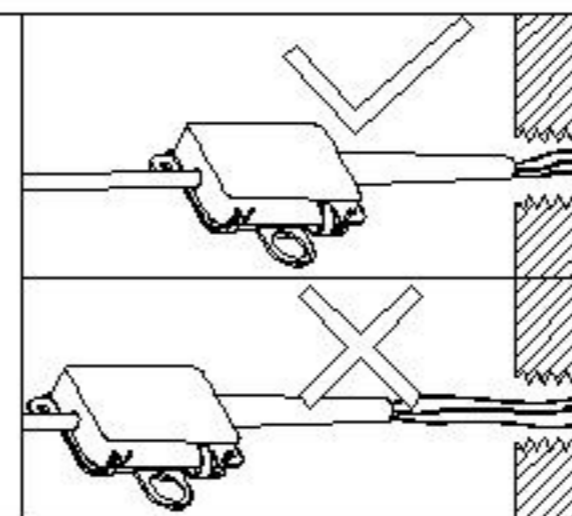
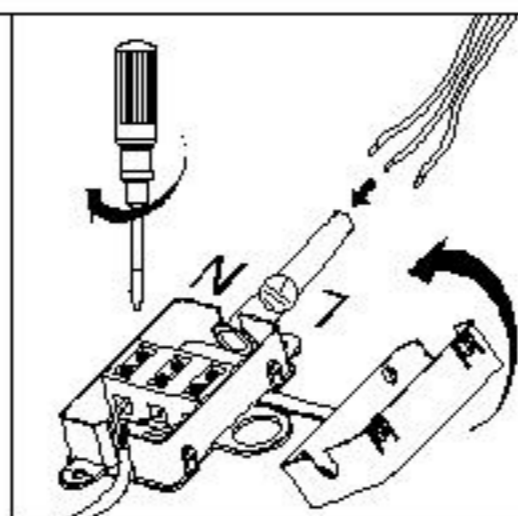
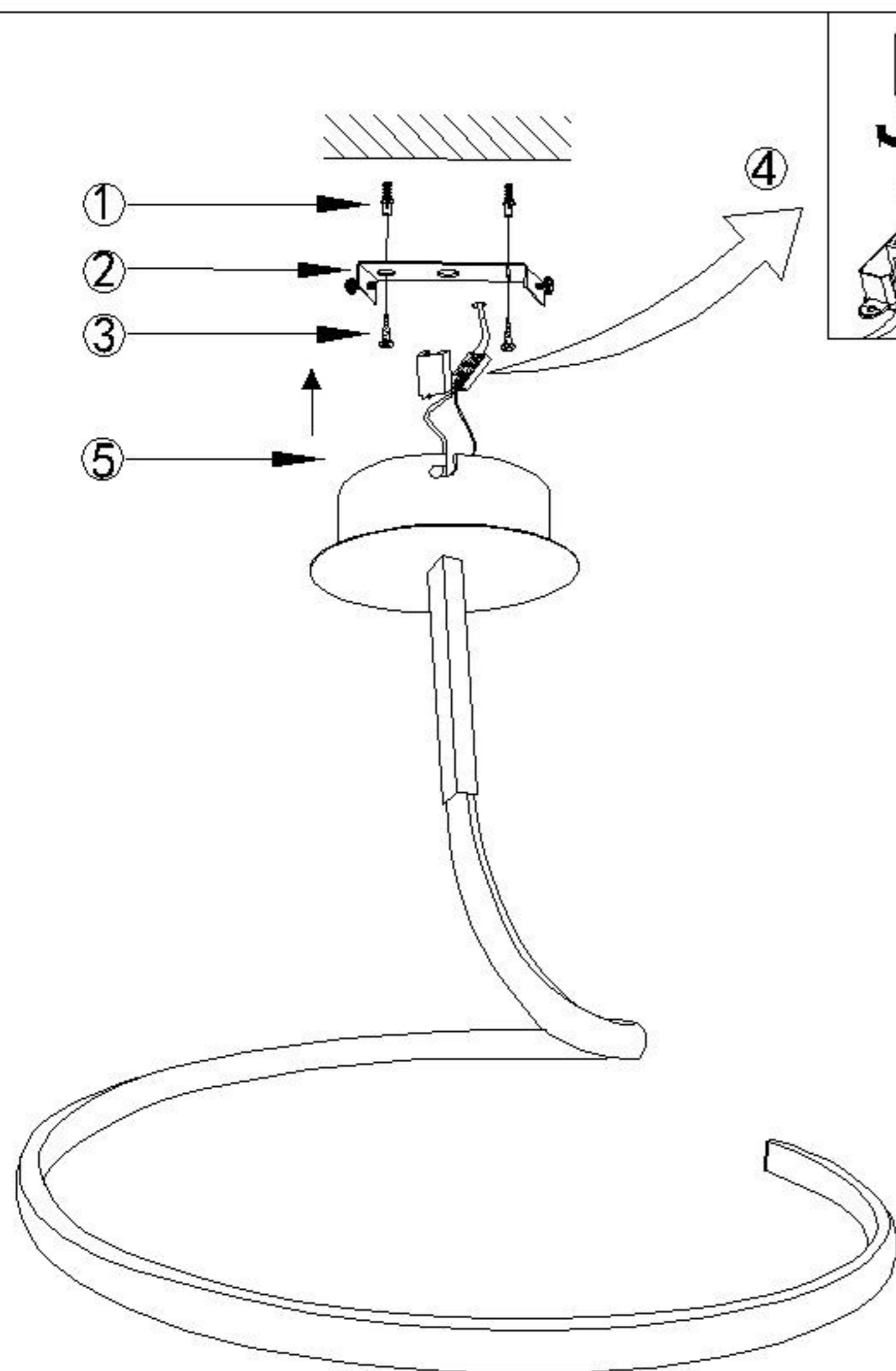

LED 30W / INCL
220-240V ~ 50/60Hz

NOTE:

- 1: This lighting is only for indoor use.
- 2: Do not switch on before assembling.
- 3: Do not manipulate the shape of the lamp

NOTA:

- 1: Esta lámpara solo podrá utilizarse en interior.
- 2: No enchufe la lámpara antes de montarla.
- 3: No manipular forma de la lámpara.

REF:
5829/4996/6002

mAntra