

INSTALLATION INSTRUCTIONS

(ILLUSTRATIONS ARE FOR GUIDANCE PURPOSES ONLY.
ACTUAL PRODUCT MAY DIFFER FROM THE IMAGES SHOWN)



(1) Prior to installation carefully unpack and check all the components and accessories are as per details enclosed.

(2) These instructions should be used in conjunction with the installation guidelines included.

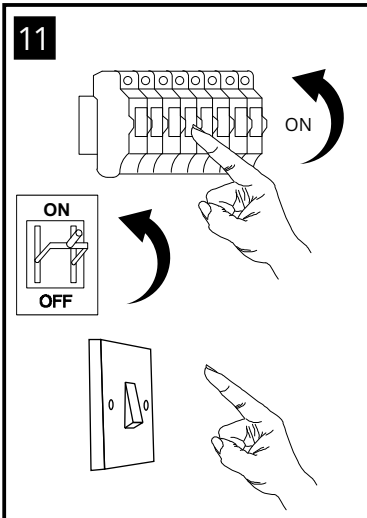
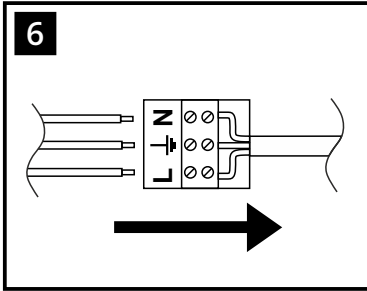
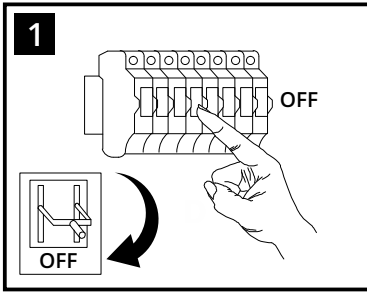

Switch on to test. Switch off and allow lamps to cool down.

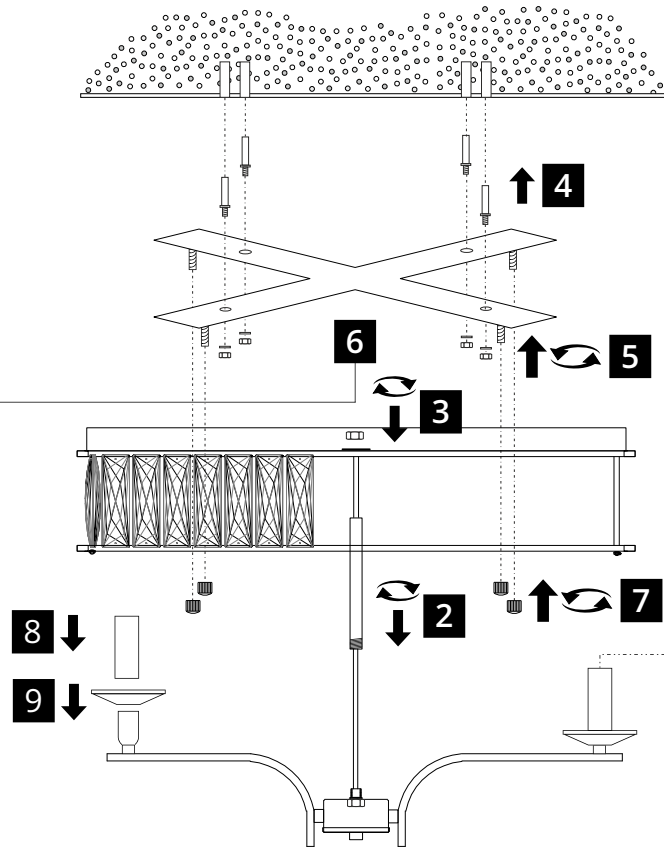

Please use the gloves provided.

*Lamps may not be included. Please ensure maximum wattage is not exceeded.

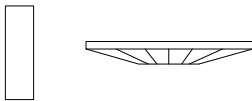

a b

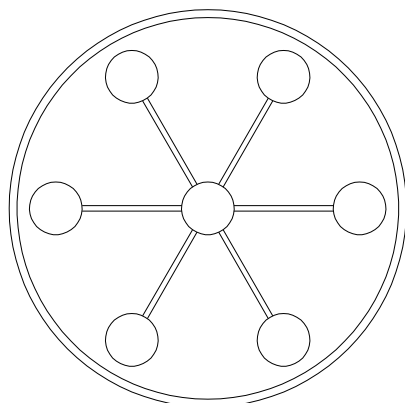
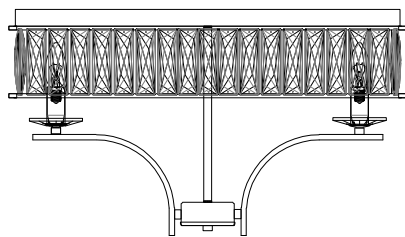

Installation Accessories

Crystal Sconce a	6 Pcs	
Lampholder Sleeve b	6 Pcs	

Installation Pack

Installation Instructions	1 Page	
Installation Guidelines	2 Pages	
Heavy Duty Bolts	4 Sets	
White Gloves	1 Pair	
Additional Crystal Links	3 Pcs Each	

Contents
Checked by

Voltage: 220-240V~50/60Hz
Lampholder: E14/SES
Lamps: 6 x LED 20W Max



UKCA WITH SUITABLE LAMP/DIMMER