

INSTALLATION INSTRUCTIONS

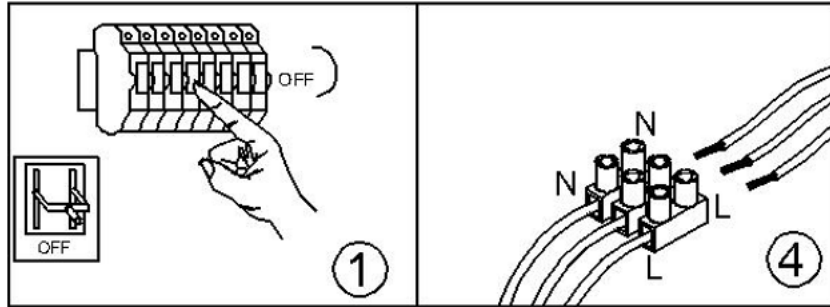

1

4

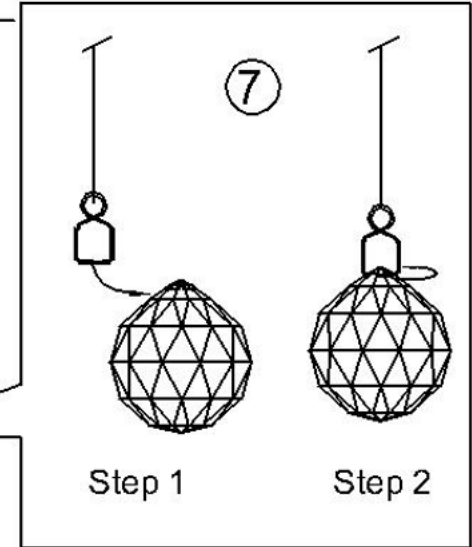
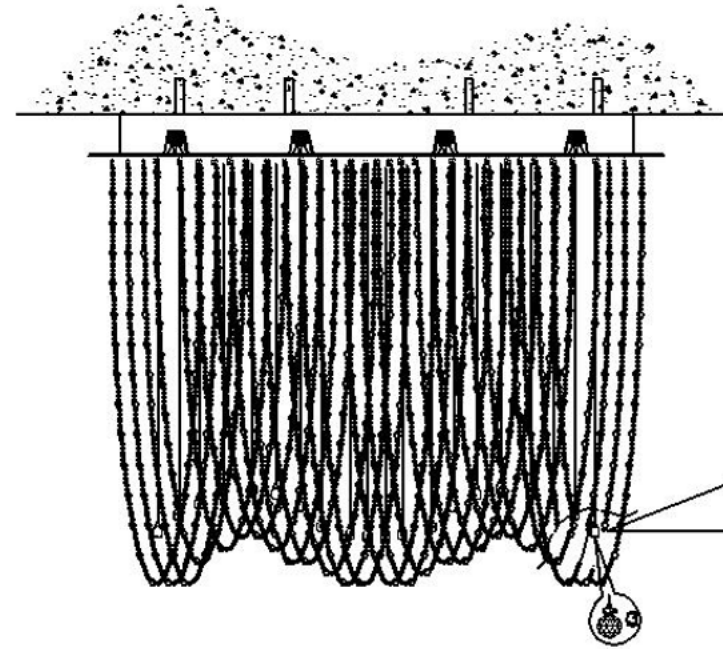

7

Step 1

Step 2

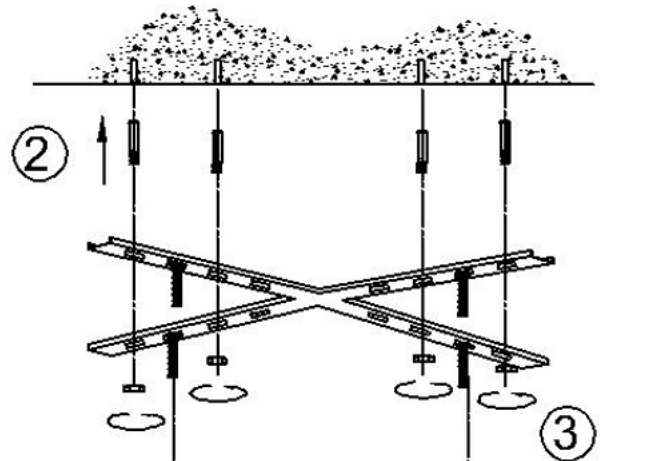

2

3

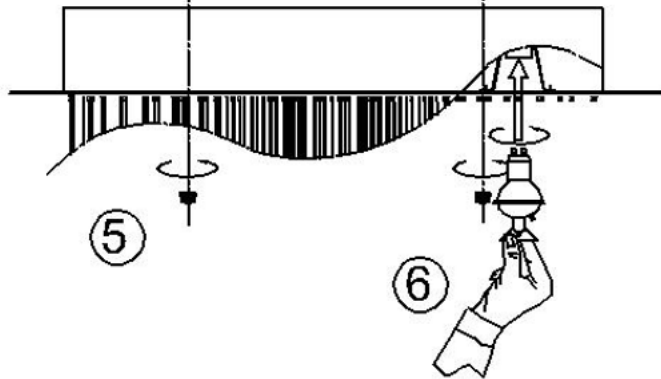

5

6

Installation Notes:

- 1: This luminaire is for indoor use only.
- 2: This luminaire requires an earth connection.
- 3: If you want to change a lamp, please switch off the luminaire and wait until lamps are cool.

Voltage: 230V
 Lampholder: GU10
 Lamp: 12 x MAX 50W
 Frequency: 50Hz

Ref: IL31393

diyas[®]

INSTALLATION INSTRUCTIONS

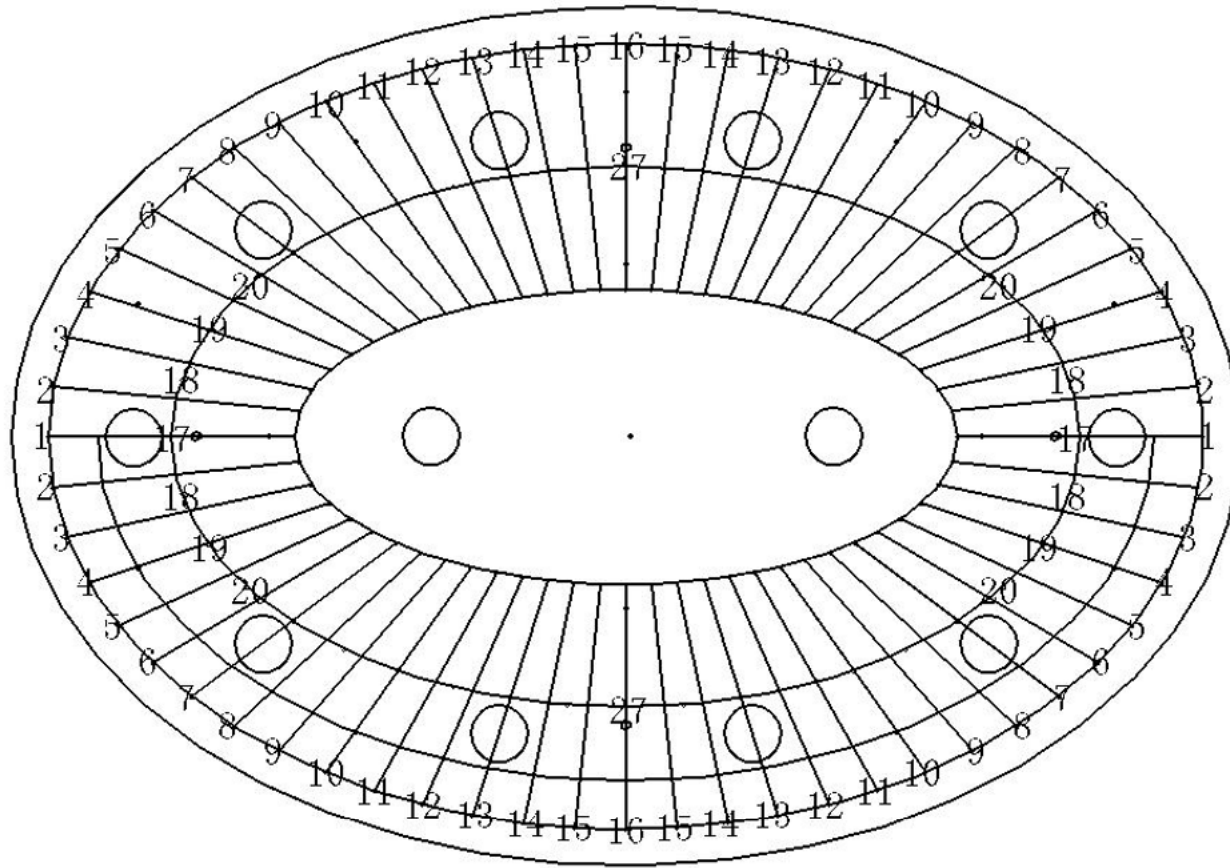

Ref: IL31393

diyas®

LIST OF COMPONENTS

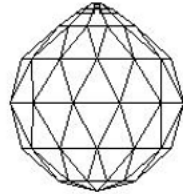

40# Crystal Ball

Crystal		
30# Crystal Ball	308 Pcs	
Installation Pack		
White Gloves	2 Pcs	
Assembly Instruction	3 Pcs	
General Instruction Leaflet	1 Pc	
Heavy Duty Bolts	8 Sets	
GU10 Lamp	12Pcs	
Additional Crystal Links	3 Pcs Each	
Plastic Tool	1Pc	
Ref: IL31393		